

# ECLIPSE<sup>®</sup>

EXTERNAL GEAR PUMP



**Flow:**  
up to 33 gpm (125 lpm)



**Differential Pressure:**  
up to 150 psi (10.3 bar)



**Working Pressure:**  
up to 300 psi (20.7 bar)



**Temperature:**  
from -40 to 450°F (-40 to 232°C)



**Viscosity:**  
up to 100,000 cPs



**75**  
*Years*  
EXCEEDING EXPECTATIONS  
SINCE 1942

NSF/ANSI 61\*  

\*Non-metallic Only

 **PULSAFEEDER<sup>®</sup>**  
ENGINEERED PRODUCTS

# ECLIPSE®

## PULSAFEEDER EXPERTISE

For over 70 years, Pulsafeeder, Inc. continues to be a proven leader in fluid handling technology and innovation in chemical dosing. With extensive experience in providing fluid handling solutions, our pumps are designed to handle even the toughest applications. Known for rugged construction and dependable performance, our products are manufactured with excellence and the highest quality standards.

The Eclipse represents a dramatic advance in pump technology. Combining proven design principles with patented features, our pumps are safe, simple, and reliable. Structurally rugged with corrosion-resistant materials, Eclipse is an ideal fit for many corrosive liquids. From acids to bases, we cover the entire pH scale.

The innovative technology behind Eclipse supports its ability to handle the most corrosive chemicals with a simple-to-service, front pull-out design. Eclipse is available with wetted components in completely non-metallic construction, 316SS, and Alloy C. These material offerings ensure corrosion resistance over a wide range of chemicals and process conditions. These pumps are magnetically driven to eliminate mechanical seal wear and leaks associated with rotating seals. The patented bearing design promotes constant lubrication.

## PRODUCT SPECIFICATIONS

### Markets

- Chemical Processing
- Oil & Gas
- Petrochemical
- Wastewater Treatment
- Water Treatment - Power
- Water Treatment - Municipal

### Typical Applications

- Sodium Hypochlorite
- Hydrogen Peroxide
- Sulfuric Acid
- Solvents
- Caustic
- Polymers
- Dyes & Inks
- Catalyst
- Cleaning Agents
- Flocculants
- Adhesives & Resins
- Acids

## COMPONENTS

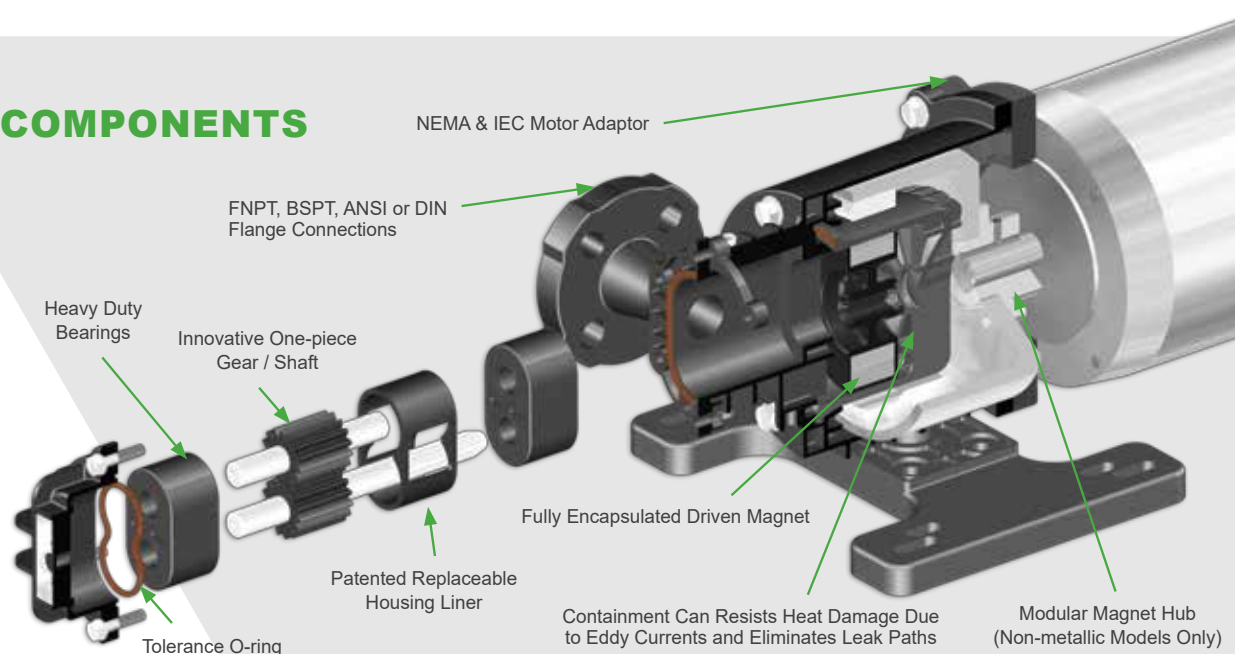

# FEATURES

## DESIGNED FOR SIMPLICITY

- Fewest number of components of any external gear pump on the market
- Simplified ordering and inventory with fewer parts
- Self-aligning parts and piloted fits ensure proper assembly every time



## RENEWABLE PERFORMANCE

- Patented housing liner protects the housing from wear
- Easy maintenance KOPkit® (Keep On Pumping kit) saves time and money
- Regain performance flow with a KOPkit®



## HEAVY DUTY BEARINGS & TOLERANCE O-RING

- Bearings have large wear areas
- Patented bearings are made from self-lubricating materials
- Tolerance O-ring maintains proper internal operating clearances



## MAGNETICALLY DRIVEN SEALLESS DESIGN

- Eliminates costly seal flush systems required for double mechanical seals
- Patented drive shaft spline design optimizes magnet alignment on shaft
- Fully encapsulated driven magnets offer maximum corrosion resistance
- Sealless design ensures zero leakage



## UNIVERSAL FLANGES

- Standard housings mate to both ANSI and DIN flange connections
- PTFE or Viton® inserts act as a gasket and can be reused or replaced to ensure a proper seal (Non-metallic only)



## UNIVERSAL MOTOR ADAPTOR

- Standard adaptors easily mate to multiple NEMA and IEC motors
- Wide range of motor adaptors allow for easy installation in retrofit applications





# E02 MODEL

## PRODUCT SPECIFICATIONS



 **Flow:**  
up to 0.45 gpm (1.7 lpm)

 **Differential Pressure:**  
up to 150 psi (10.3 bar)

 **Working Pressure:**  
up to 200 psi (13.8 bar) Non-metallic  
up to 300 psi (20.7 bar) Metallic

 **Temperature:**  
up to 200°F (93°C) Non-metallic  
up to 450°F (232°C) Metallic

 **Viscosity:**  
up to 1,000 cPs

NSF/ANSI 61\*    
\*Non-metallic Only



## DIMENSIONAL DRAWINGS

### Non-metallic

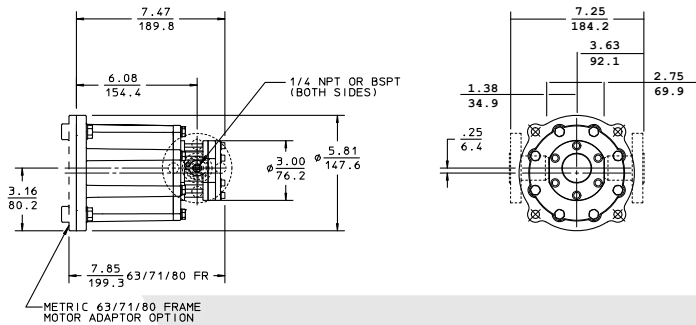

### Metallic

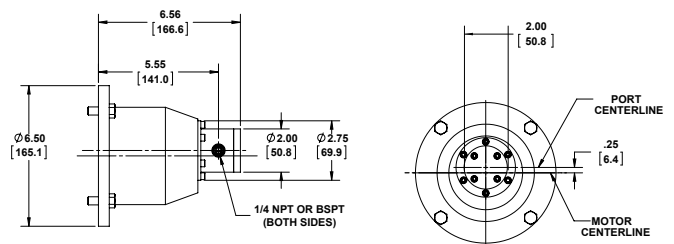

Note: For additional detailed dimensional drawings, refer to the model tech sheets on [www.pulsa.com](http://www.pulsa.com).





## MATERIALS OF CONSTRUCTION



Housing	PVDF	316SS	Alloy C
Magnet	Neodymium encapsulated in virgin PTFE	Samarium Cobalt	Samarium Cobalt
Liner	Carbon reinforced PTFE	Carbon reinforced PTFE	Carbon reinforced PTFE
Bearings	Carbon Graphite or Graphite impregnated Silicon Carbide	Carbon Graphite, Graphite impregnated Silicon Carbide, or PTFE	Carbon Graphite, Graphite impregnated Silicon Carbide, or PTFE
O-rings	Viton®, EPDM, and Kalrez® 4079	PTFE and Kalrez®	PTFE and Kalrez®



# E05 MODEL

## PRODUCT SPECIFICATIONS

-  **Flow:**  
up to 1.6 gpm (6.1 lpm)
-  **Differential Pressure:**  
up to 150 psi (10.3 bar)
-  **Working Pressure:**  
up to 200 psi (13.8 bar) Non-metallic  
up to 300 psi (20.7 bar) Metallic
-  **Temperature:**  
up to 200°F (93°C) Non-metallic  
up to 450°F (232°C) Metallic
-  **Viscosity:**  
up to 100,000 cPs

NSF/ANSI 61\*    
\*Non-metallic Only



## DIMENSIONAL DRAWINGS

### Non-metallic

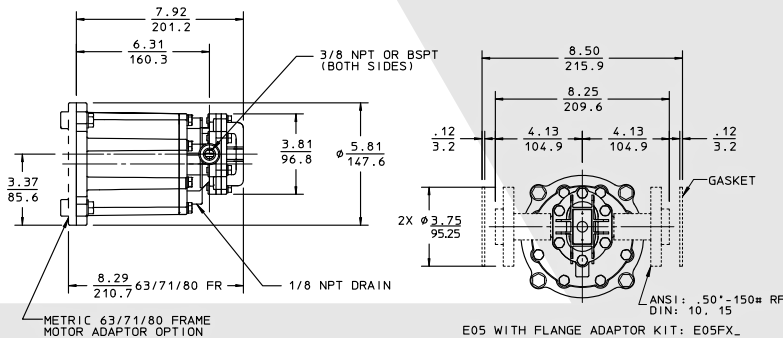

### Metallic

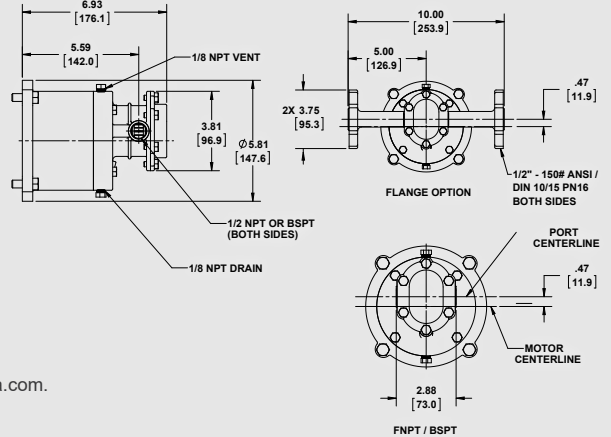





Note: For additional detailed dimensional drawings, refer to the model tech sheets on [www.pulsa.com](http://www.pulsa.com).

## MATERIALS OF CONSTRUCTION

Housing	PVDF	316SS	Alloy C
Magnet	Neodymium encapsulated in virgin PTFE	Neodymium or Samarium Cobalt	Neodymium or Samarium Cobalt
Liner	Carbon reinforced PTFE	Carbon reinforced PTFE	Carbon reinforced PTFE
Bearings	Carbon Graphite or Graphite impregnated Silicon Carbide	Carbon Graphite, Graphite impregnated Silicon Carbide, or PTFE	Carbon Graphite, Graphite impregnated Silicon Carbide, or PTFE
O-rings	Viton®, EPDM, and Kalrez® 4079	PTFE and Kalrez®	PTFE and Kalrez®

# E12 MODEL

## PRODUCT SPECIFICATIONS

-  **Flow:**  
up to 3.5 gpm (13.2 lpm)
-  **Differential Pressure:**  
up to 150 psi (10.3 bar)
-  **Working Pressure:**  
up to 200 psi (13.8 bar) Non-metallic  
up to 300 psi (20.7 bar) Metallic
-  **Temperature:**  
up to 200°F (93°C) Non-metallic  
up to 450°F (232°C) Metallic
-  **Viscosity:**  
up to 100,000 cPs

NSF/ANSI 61\*    
\*Non-metallic Only



## DIMENSIONAL DRAWINGS

### Non-metallic

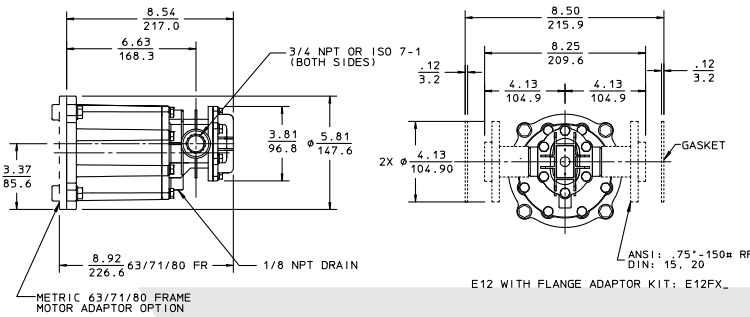

### Metallic

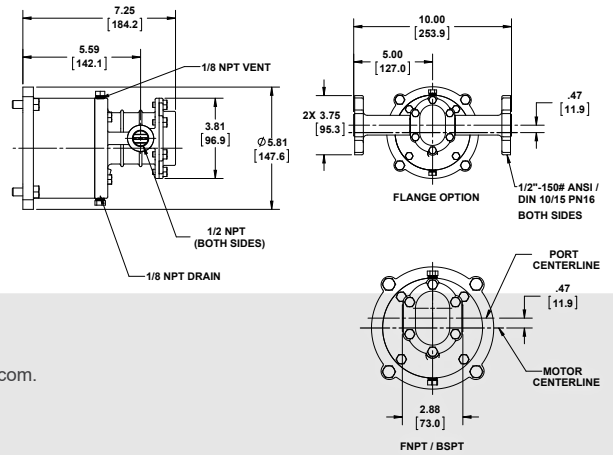





Note: For additional detailed dimensional drawings, refer to the model tech sheets on [www.pulsa.com](http://www.pulsa.com).



## MATERIALS OF CONSTRUCTION

Housing	PVDF	316SS	Alloy C
Magnet	Neodymium encapsulated in virgin PTFE	Neodymium or Samarium Cobalt	Neodymium or Samarium Cobalt
Liner	Carbon reinforced PTFE	Carbon reinforced PTFE	Carbon reinforced PTFE
Bearings	Carbon Graphite or Graphite impregnated Silicon Carbide	Carbon Graphite, Graphite impregnated Silicon Carbide, or PTFE	Carbon Graphite, Graphite impregnated Silicon Carbide, or PTFE
O-rings	Viton®, EPDM, and Kalrez® 4079	PTFE and Kalrez®	PTFE and Kalrez®

# E25 MODEL

## PRODUCT SPECIFICATIONS

-  **Flow:**  
up to 7.4 gpm (28 lpm)
-  **Differential Pressure:**  
up to 150 psi (10.3 bar)
-  **Working Pressure:**  
up to 200 psi (13.8 bar) Non-metallic  
up to 300 psi (20.7 bar) Metallic
-  **Temperature:**  
up to 200°F (93°C) Non-metallic  
up to 450°F (232°C) Metallic
-  **Viscosity:**  
up to 100,000 cPs

NSF/ANSI 61\*    
\*Non-metallic Only



## DIMENSIONAL DRAWINGS

### Non-metallic

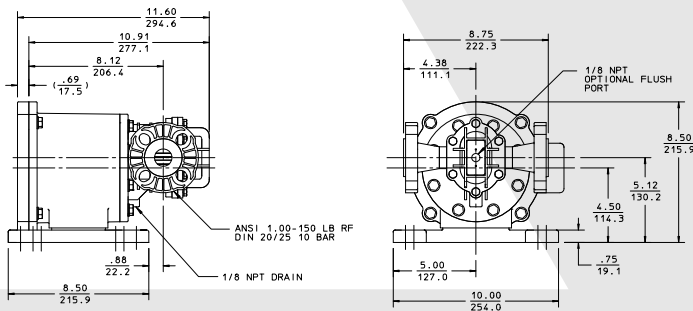

### Metallic

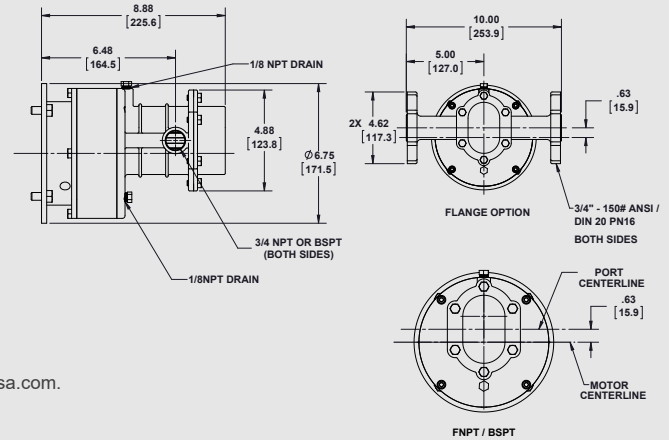





Note: For additional detailed dimensional drawings, refer to the model tech sheets on [www.pulsa.com](http://www.pulsa.com).



## MATERIALS OF CONSTRUCTION

Housing	PVDF	316SS	Alloy C
Magnet	Neodymium encapsulated in virgin PTFE	Neodymium or Samarium Cobalt	Neodymium or Samarium Cobalt
Liner	Carbon reinforced PTFE	Carbon reinforced PTFE	Carbon reinforced PTFE
Bearings	Carbon Graphite or Graphite impregnated Silicon Carbide	Carbon Graphite, Graphite impregnated Silicon Carbide, or PTFE	Carbon Graphite, Graphite impregnated Silicon Carbide, or PTFE
O-rings	Viton®, EPDM, and Kalrez® 4079	PTFE and Kalrez®	PTFE and Kalrez®

# E75 & E125 MODEL

## PRODUCT SPECIFICATIONS

-  **Flow:**  
up to 33 gpm (125 lpm)
-  **Differential Pressure:**  
up to 150 psi (10.3 bar)
-  **Working Pressure:**  
up to 200 psi (13.8 bar) Non-metallic  
up to 300 psi (20.7 bar) Metallic
-  **Temperature:**  
up to 200°F (93°C) Non-metallic  
up to 450°F (232°C) Metallic
-  **Viscosity:**  
up to 100,000 cPs

NSF/ANSI 61\*    
\*Non-metallic Only



## DIMENSIONAL DRAWINGS

Non-metallic

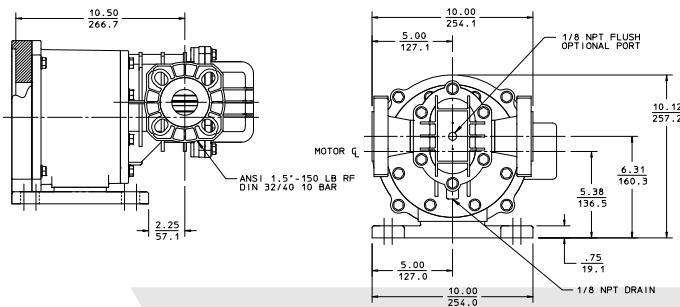

Metallic

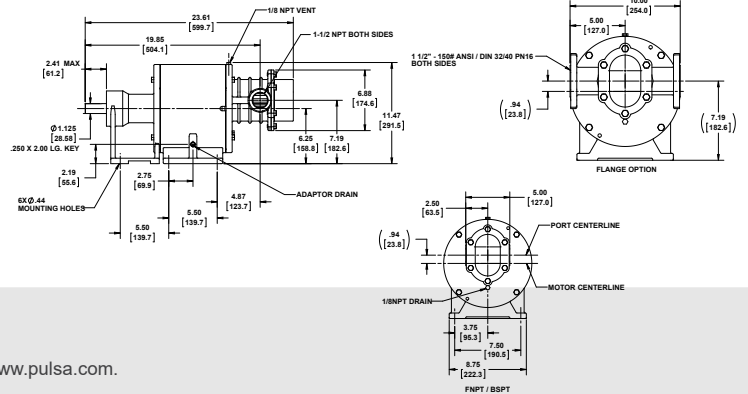

Note: For additional detailed dimensional drawings, refer to the model tech sheets on [www.pulsa.com](http://www.pulsa.com).

## MATERIALS OF CONSTRUCTION

Housing	PVDF	316SS	Alloy C
Magnet	Neodymium encapsulated in virgin PTFE	Samarium Cobalt	Samarium Cobalt
Liner	Carbon reinforced PTFE	Carbon reinforced PTFE	Carbon reinforced PTFE
Bearings	Carbon Graphite or Graphite impregnated Silicon Carbide	Carbon Graphite, Graphite impregnated Silicon Carbide, or PTFE	Carbon Graphite, Graphite impregnated Silicon Carbide, or PTFE
O-rings	Viton®, EPDM, and Kalrez® 4079	PTFE and Kalrez®	PTFE and Kalrez®



# FLOW CURVES

## E02 MODEL

Fluid Viscosity: 1 cPs, Specific Gravity 1.0  
Motor 1/4 HP (.18 kW) | Pump needs 56C Frame

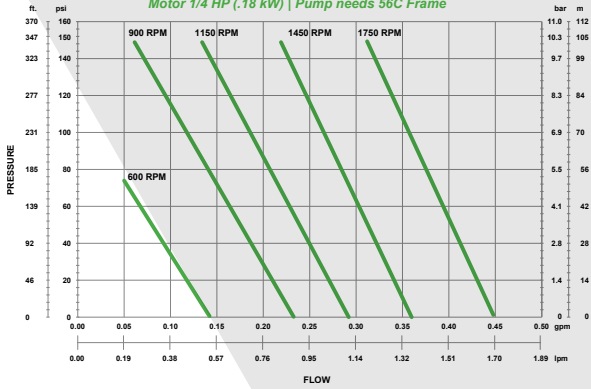

## E05 MODEL

Fluid Viscosity: 1 cPs, Specific Gravity 1.0

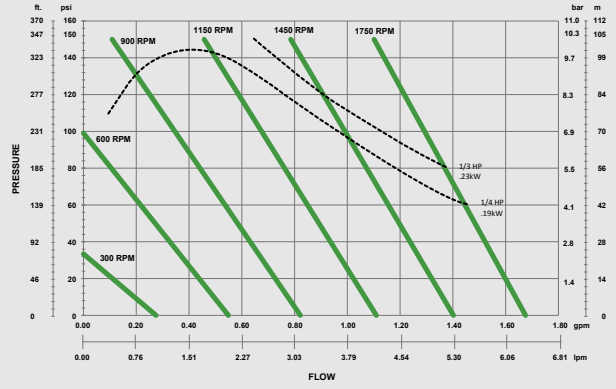

## E12 MODEL

Fluid Viscosity: 1 cPs, Specific Gravity 1.0

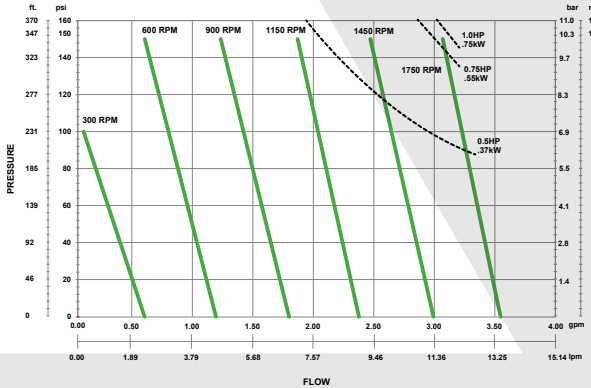

## E25 MODEL

Fluid Viscosity: 1 cPs, Specific Gravity 1.0

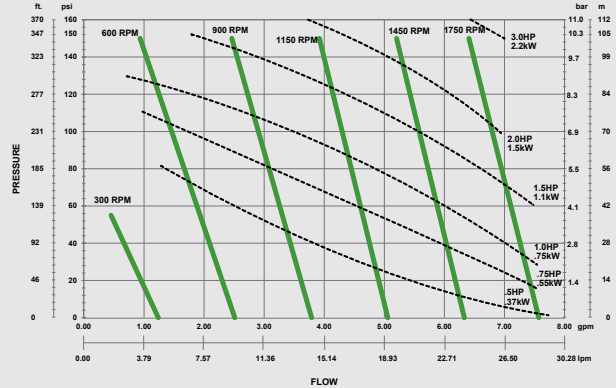

## E75 MODEL

Fluid Viscosity: 1 cPs, Specific Gravity 1.0

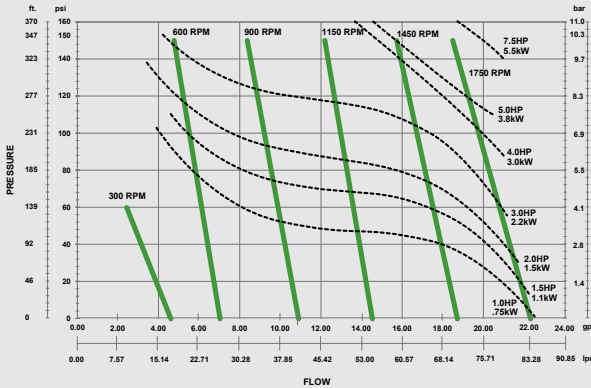

## E125 MODEL

Fluid Viscosity: 1 cPs, Specific Gravity 1.0

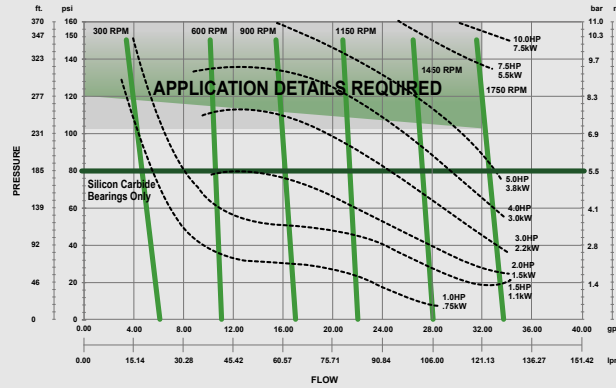

# MODEL STRINGS

## NON-METALLIC PUMP CONFIGURATION STRING

Pump Selection	Available Model	Code	Description	E_ _ _ _ _ _ _ _ _ _
Positions 1, 2, 3 PUMP SIZE	E	02	Size 02 - Max. Flow .45 gpm (1.7 lpm) 1/4"-18 FNPT / 1/4"-19 BSPT	
		05	Size 05 - Max. Flow 1.6 gpm (6.1 lpm) 3/8"-18 FNPT / 3/8"-19 BSPT	
		12	Size 12 - Max. Flow 3.5 gpm (13.2 lpm) 3/4"-14 FNPT / 3/4"-14 BSPT	
		25	Size 25 - Max. Flow 7.4 gpm (28 lpm) Flanged 1"-150# ANSI / DIN 20 / 25	
		75	Size 75 - Max. Flow 22 gpm (83.3 lpm) Flanged 1 1/2"-150# ANSI / DIN 32 / 40	
125	Size 125 - Max. Flow 33 gpm (125 lpm) Flanged 1 1/2"-150# ANSI / DIN 32 / 40			
Position 4 BASE MATERIAL	02,05	K	PVDF / FNPT	
	02,05	M	PVDF / BSPT,	
	<b>Export Restrictions apply to the following sizes listed below:</b>			
	12	K	PVDF / FNPT	
	12	M	PVDF / BSPT,	
25,75,125	N	PVDF, Flanged		
Position 5 BEARINGS	02,05,12,25,75,125	L	Carbon	
		B	Silicon Carbide	
Position 6 O-RINGS	02,05,12,25,75,125	V	Viton®	
		E	EPDM	
		K	Kalrez® Grade 4079	
Position 7 MOTOR MOUNTING ARRANGEMENTS	02,05,12,25,75	F	NEMA 56C (C-face, rigid base, 5/8" shaft diameter, 4x 3/8"-16 tapped holes on a 5-7/8" bolt circle)	
	02,05,12,25,75,125	O	NEMA 143/5TC-182/4C (C-face, rigid base, 7/8" shaft diameter, 4x 3/8"-16 tapped holes on a 5-7/8" bolt circle)	
	75,125	R	NEMA 182TC-184TC (C-face, rigid base, 1-1/8" shaft diameter, 4x 1/2"-13 tapped holes on a 7-1/4" bolt circle)	
	75,125	W	NEMA 213TC-215TC (C-face, rigid base, 1-3/8" shaft diameter, 4x 1/2"-13 tapped holes on a 7-1/4" bolt circle)	
	02,05,12	H	IEC 63 B3/B14 (rigid base, C-face, 11 mm motor shaft diameter, 4x M5 tapped holes on a 75 mm bolt circle)	
	02,05,12	J	IEC 71 B3/B14 (rigid base, C-face, 14 mm motor shaft diameter, 4x M6 tapped holes on a 85 mm bolt circle)	
	02,05,12,25,75	K	IEC 80 B3/B14 (rigid base, C-face, 19 mm motor shaft diameter, 4x M6 tapped holes on a 100 mm bolt circle)	
	25,75	L	IEC 90 B3/B14 (rigid base, C-face, 24 mm motor shaft diameter, 4x M8 tapped holes on a 115 mm bolt circle)	
	25,75,125	P	IEC 100/112 B3/B14 (rigid base, C-face, 28 mm motor shaft diameter, 4x M8 tapped holes on a 130 mm bolt circle)	
02,05,12,25,75,125	Y	NO MOTOR MOUNTING KIT (Pump includes Drive Magnet)		
Position 8	02,05,12,25,75,125	-	Dash	
Position 9 OPTIONS	02,05,12,25,75,125	X	Standard (Complete Pump - No Options)	
	05,12,25,75,125	A	Bearing Flush Port (1x 1/8" FNPT / BSPT Connection located in the center of the front cover)	
	02,05,12,25,75,125	N	Pump Wet End Only (Only available in conjunction with 7th position option "Y")	
	05,12,25,75,125	B	Combination Of 9th Position Options "A" AND "N"	
	02,05,12,25,75,125	X-ATEX	Standard Pump with ATEX Directive - CE Ex II 2G T6 II 2D T6	
	05,12,25,75,125	A-ATEX	Bearing Flush with ATEX Directive - CE Ex II 2G T6 II 2D T6	
	02,05,12,25,75,125	N-ATEX	Wet End Only with ATEX Directive - CE Ex II 2G T6 II 2D T6	
05,12,25,75,125	B-ATEX	Wet End Only and Bearing Flush with ATEX Directive - CE Ex II 2G T6 II 2D T6		

Viton® and Kalrez® are registered trademarks of E.I. du Pont de Nemours and Company.

# METALLIC PUMP CONFIGURATION STRING

Pump Selection	Available Model	Code	Description	E																																																																																									
Positions 1, 2, 3 PUMP SIZE	E	02	Size 02 - Max. Flow .45 gpm (1.7 lpm) 1/4" FNPT / 1/4" BSPT																																																																																										
		05	Size 05 - Max. Flow 1.6 gpm (6.1 lpm) 1/2" FNPT / 1/2" BSPT / Flanged .50-150# ANSI / DIN10 / 15 - PN16																																																																																										
		12	Size 12 - Max. Flow 3.5 gpm (13.2 lpm) 1/2" FNPT / 1/2" BSPT / Flanged .50-150# ANSI / DIN10 / 15 - PN16																																																																																										
		25	Size 25 - Max. Flow 7.4 gpm (28 lpm) 3/4" FNPT / 3/4" BSPT / Flanged .75"-150# ANSI / DIN 20 - PN16																																																																																										
		75	Size 75 - Max. Flow 22 gpm (83.3 lpm) 1-1/2" FNPT / 1-1/2" BSPT / Flanged 1 1/2"-150# ANSI / DIN 32 / 40 - PN16																																																																																										
		125	Size 125 - Max. Flow 33 gpm (125 lpm) 1-1/2" FNPT / 1-1/2" BSPT / Flanged 1 1/2"-150# ANSI / DIN 32 / 40 - PN16																																																																																										
Position 4 BASE MATERIAL	02,05,12,25,75,125	A	316SS / FNPT																																																																																										
	02,05,12,25,75,125	G	316SS / BSPT																																																																																										
	02,05	C	ALLOY C / FNPT																																																																																										
	02,05	S	ALLOY C / BSPT																																																																																										
	05,12,25,75,125	U	316SS / Flange																																																																																										
	05	V	ALLOY C / Flange																																																																																										
	12,25,75,125	C	ALLOY C / FNPT																																																																																										
	12,25,75,125	S	ALLOY C / BSPT																																																																																										
12,25,75,125	V	ALLOY C / Flange																																																																																											
<b>Export Restrictions apply to the following sizes listed below:</b>																																																																																													
Position 5 BEARINGS	02,05,12,25,75,125	L	Carbon																																																																																										
		B	Silicon Carbide** Silicon Carbide bearings, must select Position 9 = B or P (Alumina ceramic shafts)																																																																																										
		T	Glass Filled PTFE 110°F (43.3°C)																																																																																										
Position 6 O-RINGS	02,05,12,25,75,125	U	PTFE																																																																																										
		K	Kalrez® Grade 4079 (recommended for fluctuating temperature applications)																																																																																										
Position 7 MOTOR FRAME MOUNTING	02,05,12,25	F	NEMA 56C (C-face, rigid base, 5/8" shaft diameter, 4x 3/8"-16 tapped holes on a 5-7/8" bolt circle)																																																																																										
	05,12,25	O	NEMA 143/5TC (C-face, rigid base, 7/8" shaft diameter, 4x 3/8"-16 tapped holes on a 5-7/8" bolt circle)																																																																																										
	02	H	IEC 63 B3/B14 (rigid base, C-face, 11 mm motor shaft diameter, 4x M5 tapped holes on a 75 mm bolt circle)																																																																																										
	02,05,12	J	IEC 71 B3/B14 (rigid base, C-face, 14 mm motor shaft diameter, 4x M6 tapped holes on a 85 mm bolt circle)																																																																																										
	05,12,25	K	IEC 80 B3/B14 (rigid base, C-face, 19 mm motor shaft diameter, 4x M6 tapped holes on a 100 mm bolt circle)																																																																																										
	25	L	IEC 90 B3/B14 (rigid base, C-face, 24 mm motor shaft diameter, 4x M8 tapped holes on a 115 mm bolt circle)																																																																																										
	75,125	R	NEMA - Pedestal with 1.125" Shaft Diameter (182-184T or 213-215)																																																																																										
75,125	U	IEC - Pedestal with 28mm Shaft Diameter (100/112, B3)																																																																																											
Position 8	02,05,12,25,75,125	-	Dash																																																																																										
Position 9 SHAFT / GEAR / MAGNET OPTIONS	02,05,12,25,75,125		<table border="1"> <thead> <tr> <th rowspan="2">DRIVE (SHAFT / GEAR)</th> <th rowspan="2">IDLER (SHAFT / GEAR)</th> <th colspan="2">STANDARD MAGNET MATERIAL</th> <th rowspan="2">MAXIMUM Temperature</th> </tr> <tr> <th>E02,E75,E125</th> <th>E05,E12,E25</th> </tr> </thead> <tbody> <tr> <td>S</td> <td>316SS / PTFE</td> <td>316SS / PTFE</td> <td></td> <td>200°F (93°C)</td> </tr> <tr> <td>F</td> <td>316SS / 316SS</td> <td>316SS / PTFE</td> <td></td> <td>200°F (93°C)</td> </tr> <tr> <td>B</td> <td>ALUMINA / PTFE</td> <td>ALUMINA / PTFE</td> <td>Samarium Cobalt</td> <td>Neodymium</td> <td>200°F (93°C)</td> </tr> <tr> <td>A</td> <td>Alloy C / PTFE</td> <td>Alloy C / PTFE</td> <td></td> <td></td> <td>200°F (93°C)</td> </tr> <tr> <td>C</td> <td>Alloy C / Alloy C</td> <td>Alloy C / PTFE</td> <td></td> <td></td> <td>200°F (93°C)</td> </tr> <tr> <td>V</td> <td>316SS / 316SS</td> <td>316SS / 316SS</td> <td>NOT AVAILABLE</td> <td></td> <td>300°F (149°C)</td> </tr> <tr> <td>D</td> <td>Alloy C / Alloy C</td> <td>Alloy C / Alloy C</td> <td>NOT AVAILABLE</td> <td>Neodymium</td> <td>300°F (149°C)</td> </tr> <tr> <td>E</td> <td>Alloy C / Alloy C</td> <td>316SS / 316SS</td> <td>NOT AVAILABLE</td> <td></td> <td>300°F (149°C)</td> </tr> <tr> <td>T</td> <td>316SS / 316SS</td> <td>316SS / PEEK</td> <td></td> <td></td> <td>400°F (204°C)</td> </tr> <tr> <td>G</td> <td>Alloy C / Alloy C</td> <td>Alloy C / PEEK</td> <td>Samarium Cobalt</td> <td>Samarium Cobalt</td> <td>400°F (204°C)</td> </tr> <tr> <td>P</td> <td>ALUMINA / PEEK</td> <td>ALUMINA / PEEK</td> <td></td> <td></td> <td>400°F (204°C)</td> </tr> <tr> <td>H</td> <td>316SS / 316SS</td> <td>316SS / 316SS</td> <td></td> <td></td> <td>450°F (232°C)</td> </tr> <tr> <td>J</td> <td>Alloy C / Alloy C</td> <td>Alloy C / Alloy C</td> <td>Samarium Cobalt</td> <td>Samarium Cobalt</td> <td>450°F (232°C)</td> </tr> <tr> <td>K</td> <td>Alloy C / Alloy C</td> <td>316SS / 316SS</td> <td></td> <td></td> <td>450°F (232°C)</td> </tr> </tbody> </table>	DRIVE (SHAFT / GEAR)	IDLER (SHAFT / GEAR)	STANDARD MAGNET MATERIAL		MAXIMUM Temperature	E02,E75,E125	E05,E12,E25	S	316SS / PTFE	316SS / PTFE		200°F (93°C)	F	316SS / 316SS	316SS / PTFE		200°F (93°C)	B	ALUMINA / PTFE	ALUMINA / PTFE	Samarium Cobalt	Neodymium	200°F (93°C)	A	Alloy C / PTFE	Alloy C / PTFE			200°F (93°C)	C	Alloy C / Alloy C	Alloy C / PTFE			200°F (93°C)	V	316SS / 316SS	316SS / 316SS	NOT AVAILABLE		300°F (149°C)	D	Alloy C / Alloy C	Alloy C / Alloy C	NOT AVAILABLE	Neodymium	300°F (149°C)	E	Alloy C / Alloy C	316SS / 316SS	NOT AVAILABLE		300°F (149°C)	T	316SS / 316SS	316SS / PEEK			400°F (204°C)	G	Alloy C / Alloy C	Alloy C / PEEK	Samarium Cobalt	Samarium Cobalt	400°F (204°C)	P	ALUMINA / PEEK	ALUMINA / PEEK			400°F (204°C)	H	316SS / 316SS	316SS / 316SS			450°F (232°C)	J	Alloy C / Alloy C	Alloy C / Alloy C	Samarium Cobalt	Samarium Cobalt	450°F (232°C)	K	Alloy C / Alloy C	316SS / 316SS			450°F (232°C)	
		DRIVE (SHAFT / GEAR)	IDLER (SHAFT / GEAR)			STANDARD MAGNET MATERIAL			MAXIMUM Temperature																																																																																				
				E02,E75,E125	E05,E12,E25																																																																																								
		S	316SS / PTFE	316SS / PTFE		200°F (93°C)																																																																																							
		F	316SS / 316SS	316SS / PTFE		200°F (93°C)																																																																																							
		B	ALUMINA / PTFE	ALUMINA / PTFE	Samarium Cobalt	Neodymium	200°F (93°C)																																																																																						
		A	Alloy C / PTFE	Alloy C / PTFE			200°F (93°C)																																																																																						
		C	Alloy C / Alloy C	Alloy C / PTFE			200°F (93°C)																																																																																						
		V	316SS / 316SS	316SS / 316SS	NOT AVAILABLE		300°F (149°C)																																																																																						
		D	Alloy C / Alloy C	Alloy C / Alloy C	NOT AVAILABLE	Neodymium	300°F (149°C)																																																																																						
		E	Alloy C / Alloy C	316SS / 316SS	NOT AVAILABLE		300°F (149°C)																																																																																						
		T	316SS / 316SS	316SS / PEEK			400°F (204°C)																																																																																						
		G	Alloy C / Alloy C	Alloy C / PEEK	Samarium Cobalt	Samarium Cobalt	400°F (204°C)																																																																																						
P	ALUMINA / PEEK	ALUMINA / PEEK			400°F (204°C)																																																																																								
H	316SS / 316SS	316SS / 316SS			450°F (232°C)																																																																																								
J	Alloy C / Alloy C	Alloy C / Alloy C	Samarium Cobalt	Samarium Cobalt	450°F (232°C)																																																																																								
K	Alloy C / Alloy C	316SS / 316SS			450°F (232°C)																																																																																								
Position 10 OPTIONS	02,05,12,25,75,125	N	WET END ONLY (Requires 7th position code identifying motor frame mounting)																																																																																										

All pumps include ATEX Directive - CE Ex II 2G TX II 2D TX



## **KOPKIT<sup>®</sup> (KEEP ON PUMPING KIT)**

- Designed to guard against unnecessary downtime and assure the highest level of efficient and uninterrupted service from your pump.
- In the event of a breakdown, KOPkit<sup>®</sup> will put you back in business fast!



## **BACK PRESSURE VALVES**

- Particularly useful in metering applications or other low-flow systems
- Prevents mainstream pressure surges and siphoning



## **PRESSURE GAUGES**

- Relied on to measure pressure in the system. Proper pressure is necessary to ensure flow.
- Accurate and reliable.



## **PRESSURE RELIEF VALVES**

- Prevent an over pressurization situation from damaging your pump or system.



## **Y-STRAINERS**

- Capture out debris in pipelines, protecting equipment and processes.
- Prevent premature wear of the rotating components within a pump.

